

XR3000 SPOT CMY



User's Manual Rel 1.3 GB

D.T.S. Illuminazione srl - ITALY
<http://www.dts-lighting.it>



The Lighting Company

Made in Italy

Le informazioni contenute in questo documento sono state attentamente redatte e controllate. Tuttavia non è assunta alcuna responsabilità per eventuali inesattezze. Tutti i diritti sono riservati e questo documento non può essere copiato, fotocopiato, riprodotto per intero o in parte senza previo consenso scritto della D.T.S .

D.T.S. si riserva il diritto di apportare senza preavviso cambiamenti e modifiche estetiche , funzionali o di design a ciascun proprio prodotto. D.T.S non assume alcuna responsabilità sull'uso o sull'applicazione dei prodotti o dei circuiti descritti.

The information contained in this publication has been carefully prepared and checked. However, no responsibility will be taken for any errors. All rights are reserved and this document cannot be copied, photocopied or reproduced, in part or completely, without prior written consent from D.T.S. D.T.S. reserves the right to make any aesthetic, functional or design modifications to any of its products without prior notice. D.T.S. assumes no responsibility for the use or application of the products or circuits described herein.

Les informations contenues dans le présent manuel ont été rédigées et contrôlées avec le plus grand soin. Nous déclinons toutefois toute responsabilité en cas d'éventuelles inexactitudes. Tous droits réservés. Ce document ne peut être copié, photocopié ou reproduit, dans sa totalité ou partiellement, sans le consentement préalable de D.T.S.

D.T.S. se réserve le droit d'apporter toutes modifications et améliorations esthétiques, fonctionnelles ou de design, sans préavis, à chacun de ses produits. D.T.S. décline toute responsabilité sur l'utilisation ou sur l'application des produits ou des circuits décrits.

Las informaciones contenidas en este documento han sido cuidadosamente redactadas y controladas. Con todo, no se asume ninguna responsabilidad por eventuales inexactitudes. Todos los derechos han sido reservados y este documento no puede ser copiado, fotocopiado o reproducido, total o parcialmente, sin previa autorización escrita de D.T.S.

D.T.S. se reserva el derecho a aportar sin previo aviso cambios y modificaciones de carácter estético, funcional o de diseño a cada producto suyo. D.T.S. no se asume responsabilidad de ningún tipo sobre la utilización o sobre la aplicación de los productos o de los circuitos descritos.

INDEX:

1- SYMBOLS	4
2- GENERAL WARNING	4
3- GENERAL WARRANTY CONDITION	4
4- TECHNICAL FEATURES	5
5- ACCESSORIES	7
6- IMPORTANT SAFETY INFORMATION	8
6.1 Fire prevention	
6.2 Prevention of electric shock	
6.3 Protection against ultraviolet radiation	
6.4 Safety	
6.5 Level of protection against the penetration of solid and liquid objects	
7- MOUNTING THE LAMP	9
7.1 Lamp alignment	
8- VOLTAGE AND FREQUENCY	10
9- INSTALLATION	10
9.1 Safety cable	
9.2 Protection against liquids	
9.3 Movement	
9.4 Risk of fire	
9.5 Forced ventilation	
9.6 Ambient temperature	
10- MAINS CONNECTION	11
10.1 Protection	
11- DMX SIGNAL CONNECTION	12
11.1 DMX Addresses	
11.2 Selecting the DMX address	
12- FIRMWARE UPDATING	13
13- DISPLAY FUNCTIONS	14
14- ERROR MESSAGES	17
15- HIDDEN MENU	18
15.1 Calibration mode	19
16- PAN & TILT SPEED	20
17- FANS SPEED	
18- OPENING THE PROJECTOR HOUSING	21
19- REPLACING GOBOS	
20- PERIODIC CLEANING	22
20.1 Lenses and reflectors	
20.2 Fans and air passages	
21- PERIODIC CONTROLS	
22- DMX PROTOCOL	23
23- 8 MOTORS CONTROL CARD	38
24- 8 MOTORS SLAVE CONTROL CARD	39
25- PAN & TILT CARD	40
26- CABLES RESEND CARD	
27- DISPLAY CARD	
28- LAMP ON-OFF CONTROL CARD	
29- ROTATING GOBO WHEEL	41
30- FIXED GOBO WHEEL	42
31- COLOUR WHEEL 1	43

1- SYMBOLS

Graphic symbols used on this manual



THIS SYMBOL INDICATES A HOT SURFACE



THIS SYMBOL INDICATES ELECTRIC SHOCK RISK



THIS SYMBOL INDICATES GENERAL RISK



THIS SYMBOL MEANS "DO NOT PLACE THE UNIT ON INFLAMMABLE SURFACES"

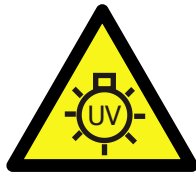

THIS SYMBOL MEANS "RADIATION FROM THIS LAMP CAN CAUSE DAMAGE TO EYES AND SKIN"



THIS SYMBOL INDICATES THE MINIMUM DISTANCE TO BE KEPT BETWEEN THE DEVICE AND THE LIT OBJECT

2- GENERAL WARNING

Read the instruction contained in this user manual carefully, as they give important information regarding safety during installation , use and maintenance.

The device is not for domestic use and must be installed by a qualified electrician or experienced person.

Always disconnect the device from the mains before replacing the lamp.

The lamp must be replaced if it has been damaged or deformed by prolonged use or overheating.

The device must always be equipped with an efficient ground connection.

3- GENERAL WARRANTY CONDITIONS

The unit is guaranteed for 24 months from the date of purchase against manufacturing material defects.

4- TECHNICAL FEATURES

The XR3000 SPOT CMY is one of the most powerful moving heads in the 1200W range.

The XR3000 SPOT CMY in fact delivers a massive 85.000 Lux at 5 m (10° beam angle), thanks to its improved optical group and dichroic glass reflector, combined with a Philips MSR Gold 1200 Fastfit lamp (95.000 Lumens).

The XR3000 SPOT CMY is particularly suitable for all professional applications, both mobile (concerts, shows, tours, special events) and fixed (clubs and other venues), requiring a light with extremely high luminous output and versatility of functions.

The XR3000 SPOT CMY is also the ideal light for a vast range of applications in which quiet operation is a priority, thanks to its silent ventilation system and silent pan/tilt operation.

The XR3000 SPOT CMY incorporates motorized focus; motorized iris; linear zoom (10°- 35°); a sophisticated CMY colour synthesis system with 3 palettes for linear insertion, plus a colour wheel (7 colours + open); 2 gobo wheels: one customizable rotating gobo wheel (7 gobos) and one customizable fixed gobo wheel (8 gobos); frost filter (soft edge); 3-facet rotating prism; animation wheel rotating in both directions.

The 16 bit Pan/Tilt mechanism features an exclusive Super Speed function, and a locking system with recessed buttons. Access to every feature of the internal menu is simple and direct, thanks to the new user interface featuring a LCD backlit graphic display (128 x 64).

XR3000 SPOT CMY

(Cod. 03.MS011.EB.L)

• Electronic ballast 90-245V 50/60 Hz • Black finish

Also available with white finish (RAL 9003) on demand

Lamp

Lamp: Philips MSR Gold 1200 Fastfit

Automatic switching ON of lamp in case of accidental switching OFF.

Lamp ON/OFF via DMX; Reset via DMX.

Optical group

85.000 Lux at 5 m (10° beam angle)

Dichroic glass reflector

Focus

Motorized focus

Iris

Motorized iris (16 bit)

Zoom

Motorized zoom (10°- 35°)

4- TECHNICAL FEATURES

Dimmer / shutter / strobo

Linear dimmer

Shutter

Strobe from 0,85 flash/sec to 10 flash/sec

Colours

CMY colour synthesis system + colour wheel (7 colours + open) with linear selection for perfect 2-colour beams

Colour change with blackout sync; rainbow effect

Gobos

1 customizable rotating gobo wheel (7 gobos)

1 customizable fixed gobo wheel (8 gobos); extractable gobo holders

Gobo change with synchronized blackout

Gobo scrolling; Gobo shake

Effects

Indexable prism rotating in both directions (3-facet)

Frost filter (soft edge)

Animation wheel rotating in both directions

Pan / Tilt

Pan 540° (3,9 sec.); Tilt 270° (2,6 sec.); 16-bit resolution

Super Speed function; extremely smooth and precise movements even at the highest speeds

Pan / Tilt locking system with recessed buttons

Automatic Pan/Tilt repositioning in case of knocks

30 DMX channels (Default)

Internal operating system updatable via DMX

Interface

LCD backlit graphic display (128x64)

Connections

4 XLR connectors (3-pole In and Out; 5-pole In and Out) by Neutrik

POWERCONN connector by Neutrik

Power supply

Electronic ballast: 90 - 260 V (50/60 Hz)

Power consumption: 1400 W

Power saving mode (the lamp dims to 50% six seconds after shutter closure)

Standard accessories

2 x "C" GQuick clamps with "fastlock" connection

Thermal

Operating ambient temperature: -10° / 40°

Weight

46,5 Kg

4- TECHNICAL FEATURES

Dimensions

Packaging Dimensions (LxWxH)

670 x 550 x 730 mm

Weight: 51,5 Kg

Unit Dimensions (LxWxH)

568x510x826mm

Weight: 46,5 Kg

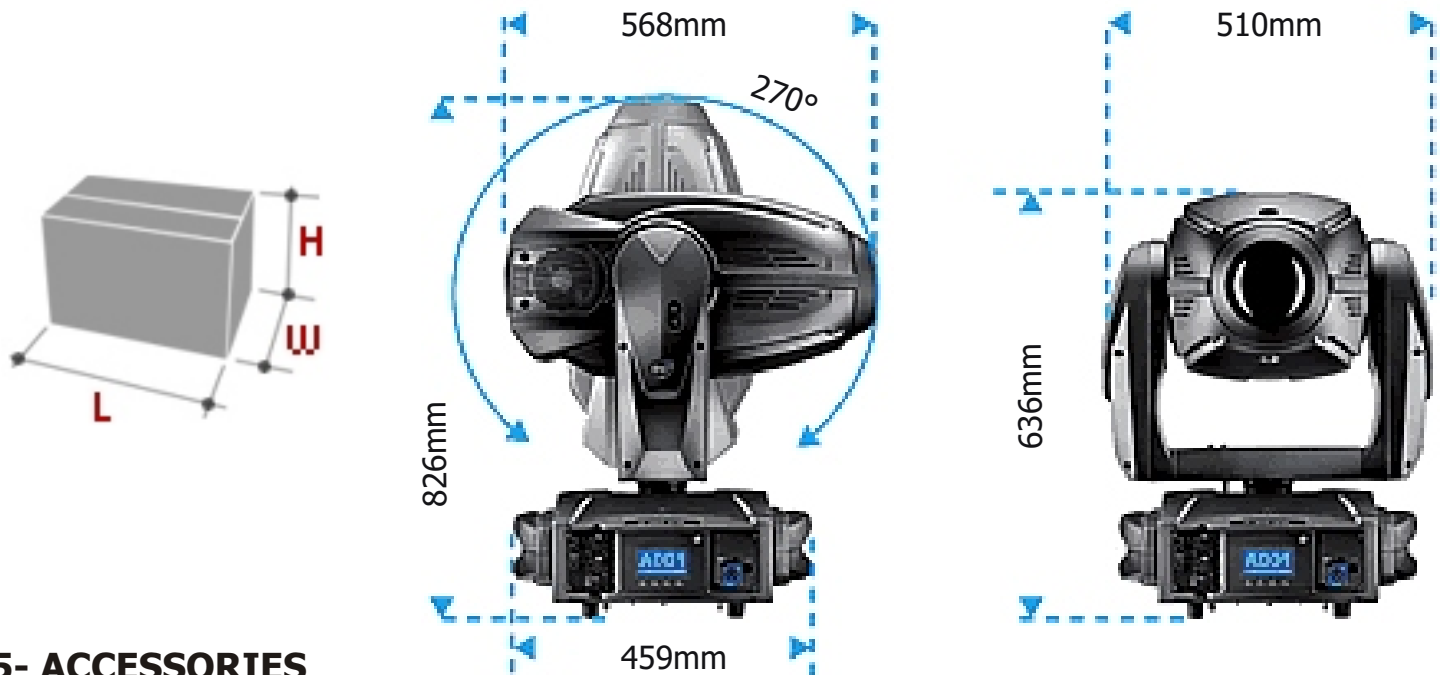

5- ACCESSORIES

As standard





- 1 x MSR Gold 1200 Fastfit lamp
- 1 x POWERCONN male cable connector (cod. 0520P014)
- 1 x XLR 5 Pins male cable connector (cod. 0508B028)
- 1 x XLR 5 Pins female cable connector (cod. 0508B027)
- 2 x "C" Clamp GQUICK with "Fast Lock" connection 1/4 turn (max. load. 80Kg) (cod. 0521A014)
- User's manual

Optional (on request)

- Wireless DMX receiver card (cod. 03.LA.012)
- "C" Clamp G60 black (max. load 50Kg) (cod. 0521A004)
- "C" Clamp G60 chrome (max. load. 50Kg) (cod. 0521A004.20)
- "C" Clamp GQUICK with "Fast Lock" connection 1/4 turn (max. load. 80Kg) (cod. 0521A014)
- "C" Clamp G100 black / professional (max. load. 200Kg) (cod. 0521A015)
- Omega clamp with "Fast Lock" connection 1/4 turn (cod. 02K00467)
- Safety wire (3mm x 60 cm), ring spring catch, max. capacity load 60Kg (cod. 0521A010)

6- IMPORTANT SAFETY INFORMATION

6.1 Fire prevention:

- XR3000 SPOT CMY uses a PHILIPS MSR Gold 1200 Fastfit lamp
 The use of any other alternative lamp is not recommended and will null and void the fixture's warranty.
- Never locate the fixture on any flammable surface. 
 - Minimum distance from flammable materials: 1.5 MT. 
 - Minimum distance from the closest illuminable surface: 2 MT.  12M 
 - Replace any blown or damaged fuses only with those of identical value. Refer to the wiring diagram if there is any doubt.
 - Connect the projector to mains power via a thermal magnetic circuit breaker.

6.2 Prevention of electric shock:



- High voltage is present inside the unit. Unplug the unit prior to performing any function which involves touching the inside of the moving head, including lamp replacement.
- The level of technology inherent in the XR3000 SPOT CMY requires the assistance of specialised personnel for all servicing. Please refer to an authorised D.T.S. service centre.
- A good earth connection is essential for proper functioning of the projector.
- Never connect the unit without proper earth connection.
- The fixture should be located in places with a good air ventilation.

6.3 Protection against ultraviolet radiation:



- Never turn on the lamp if any of the lenses, filters or ABS covering are damaged. Their respective shielding functions will only operate efficiently if they are in perfect working order.
- Never look directly the lamp when it is on.

6.4 Safety:



- The projector should always be installed with bolts, clamps and other tools that are capable of supporting the weight of the unit.
- Always use a second safety cable to sustain the weight of the unit in case of the failure of the main fixing point.
- The external surface of the unit, at various points, may exceed 70°C. Never handle the unit until at least 10 minutes have elapsed since the lamp was turned off. 
- Always replace the lamp if any physical damage is evident.
- Never install the fixture in an enclosed area lacking sufficient air flow. The ambient temperature should not exceed 40°C.
- A hot lamp may explode, so always wait for at least 10 minutes prior to attempting to replace the lamp.
- Always wear suitable hand protection when handling the lamp.

6.5 Level of protection against the penetration of solid and liquid objects:



-The projector is classified as an ordinary appliance and its protection level against the penetration of solid and liquid objects is IP 20.

For outdoor use, D.T.S. recommend the use of the dedicated raincovers:

- Raincover for XR3000 base (top) (cod. 03.MA009)
- Raincover for XR3000 base (bottom) (cod. 03.MA010)

7- MOUNTING THE LAMPS

Warning: Switch off the unit before replacing the lamp.



Philips MSR Gold 1200 Fastfit
 Power 1200W
 Luminous flux 95,000 lm
 Colour temperature 6.300°K
 Lampbase PGJX50
 Rated life 750 hours

1) Using a screwdriver, loose the 3 screws A, B, C, (photo 1) and remove the metal cover .

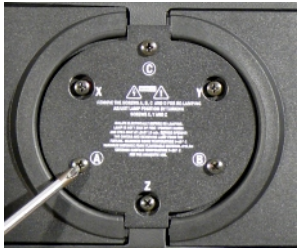

Photo 1

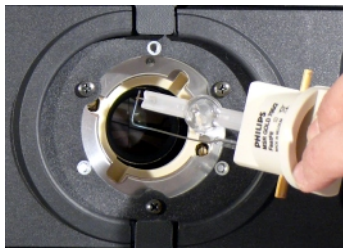

Photo 2

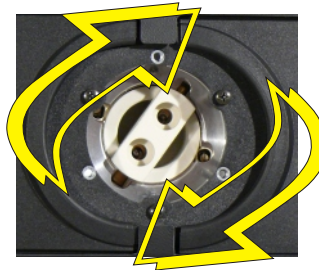

Photo 3

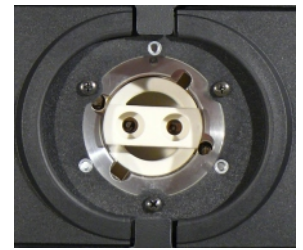

Photo 4

2) Insert the lamp (photo2).

3) Rotate the lamp 1/4 turn clockwise (photo 3 and 4).

The lamp used on XR3000 SPOT CMY is made in quartz glass and should be handled with care. Always follow the instructions supplied in the lamp's packaging. Never touch the glass directly but use the tissue provided in the lamp's packaging. The PGJX50 lamp socket is not symmetrical.

DO NOT USE UNDUE FORCE ON THE GLASS. In case of difficulty, read again the instructions and repeat the procedure.

4) Replace the metal cover and tighten the screws A,B,C, which were previously removed.

WARNING: Never look directly at the lamp when it's lit.

Discharge lamps emits UV rays; radiation from this lamp can cause damage to eyes and skin.



7.1 Lamp alignment

Attention: we recommend to align the lamp in the optical system to avoid overheating of the dichroic filters and other components inside the unit. The lamp alignment is also essential to obtain the maximum uniformity and luminous performance by the projection.

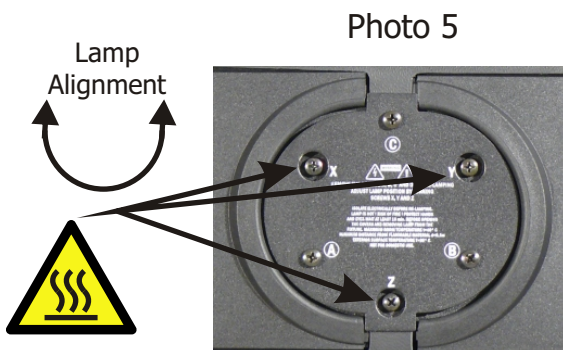
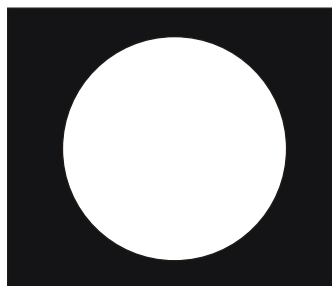

Photo 5

Normal

Hot Spot



1) Mount the fixture in an orientation so that it may be squarely projected onto a smooth white surface no less than 3 meters away. 2) Using a console or the menu system, focus an open (white) beam onto the surface and observe the beam. 3) Using a phillips-head screw driver, rotate the 3 adjusters X, Y and Z (photo 5) until you achieve a uniform flat field.

When the lamp is correctly optimized, you will have an evenly projected light beam, with no shadows or zones wich are brighter than others.

8- VOLTAGE AND FREQUENCY

The XR3000 SPOT CMY with electronic ballast can operate at 90-260 VOLT 50 or 60 Hz.

9- INSTALLATION

XR3000 SPOT CMY may be either floor or ceiling mounted.

For floor mounting installations, the XR3000 SPOT CMY is supplied with four rubber mounting feet on the base.

For ceiling mounted installations, we recommend the use of appropriate clamps to fix the unit to the mounting surface.

The supporting structure from which the unit is hung should be capable of bearing the weight of the unit, as should any clamps used to hang it. The structure should also be sufficiently rigid so as not to move or shake whilst the XR3000 SPOT CMY is moving.

Eight 1/4 turn Fast Locks connections placed in the base of the unit allow to fix the XR3000 SPOT CMY in any position, by using the two Fast Lock "C" clamps provided in the box.

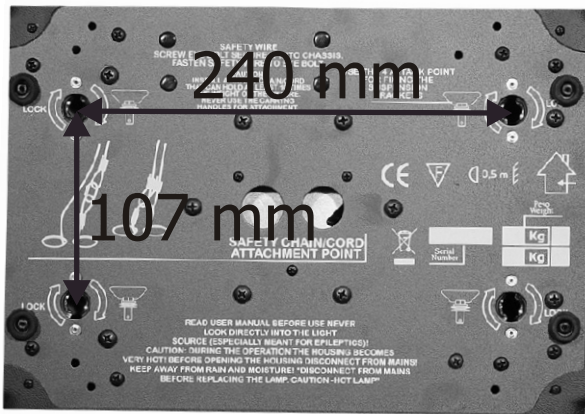

9.1- Safety cable

We recommend the use of a safety cable connected to the XR3000 SPOT CMY and to the suspension truss in order to avoid the fixture accidentally falling should the main fixing point fail. Make sure that the iron cable can bear the weight of the entire unit.

You may attach the safety cable to the two holes (A) located on the base of the fixture, as shown in the picture below.

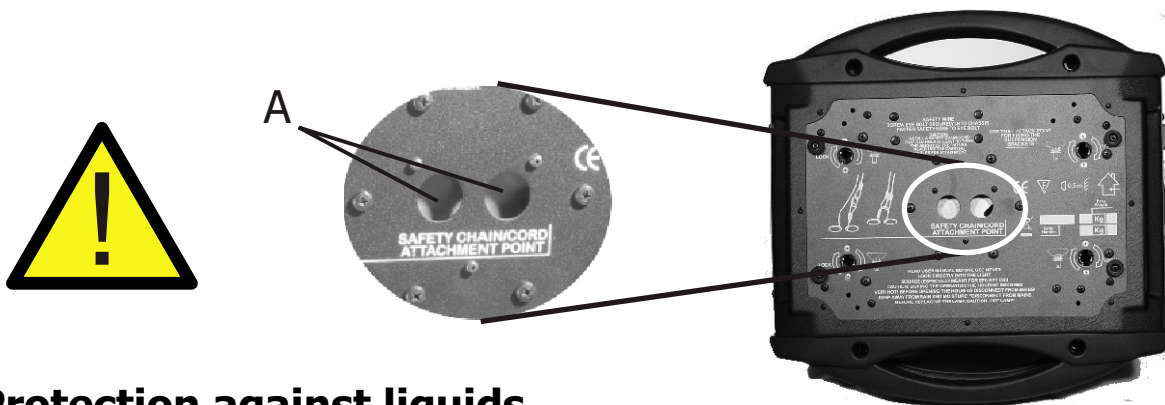

9.2- Protection against liquids

The projector contains electric and electronic components which should under no circumstances come into contact with oil, water or any other liquid. The proper unit functioning would be compromised should this occur.

9.3- Movement

The projector has a maximum movement of 540° for Pan and 270° for Tilt. DO NOT place any obstructions in the path of the projector's movement.



WARNING

Do not place any object in the path of the projector's movement



9.4- Risk of fire

Each fixture produces heat and must be installed in a well-ventilated place. The minimum recommended distance from flammable material is 1 MT.



Minimum distance from the object being illuminated is 2 MT. $\varnothing 2M$

9.5- Forced ventilation

You will note, on inspection, that the unit features various air inlets and cooling fans located on both the base and head of the fixture. These should, under no circumstances, be blocked or obstructed whilst the projector is in operation.

Doing so could cause the fixture to seriously overheat thereby compromising its proper operation.

9.6- Ambient temperature

The projector should never be installed in places that lack a constant air flow. The ambient temperature should NOT exceed 40°C.

10- MAINS CONNECTION

XR3000 SPOT CMY with electronic ballast operate at 90-260 VOLT 50-60 Hz.

Prior to connecting the unit to your mains supply, ensure that the model in your possession correctly matches the mains supply available. For connection purposes, ensure that your plug is capable of supporting 8 amps at 230V, Or 16 amps at 100-120 V

Strict adherence to regulatory norms is strongly recommended.



Electronic ballast
90-260V 50 / 60Hz

10.1- Protection

The use of a thermal magnetic circuit breaker is recommended for each XR3000 SPOT CMY. A good earth connection is essential for the correct operation of the projector.



11- DMX SIGNAL CONNECTION

The unit operates using the digital DMX 512 (1990) signal. Connection between the mixer and the projector or between projectors must be carried out using a two pair screened \varnothing 0.5 mm cable and a XLR 5 or 3 pins connector. Ensure that the conductors do not touch each other. Do not connect the cable ground to the XLR chassis

The plug housing must be isolated. Connect the mixer signal to the DMX IN projector plug and connect it to the next projector by connecting the DMX OUT plug on the first projector to the DMX IN plug of the second one.

This way, all the projectors are cascade connected.

NB. If the display showing the DMX address flashes, then one of the following errors has occurred:

- DMX signal not present
- DMX address not valid
- DMX reception problem



For Installations where long distance DMX cable connections are needed, we suggest to use a DMX terminator.

The DMX terminator is a male XLR 3-5 pins connector with a 120 ohm resistor between pin 2 and 3.

The DMX terminator must be plugged into the last unit (DMX out panel connector) of the DMX line.

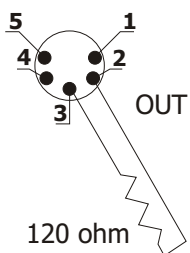

PLACE A 120 OHM RESISTOR BETWEEN PIN 2 AND 3 OF A MALE XRL CONNECTOR AND PLUG IT INTO THE DMX OUT PANEL CONNECTOR OF THE LAST UNIT CONNECTED TO THE DMX LINE

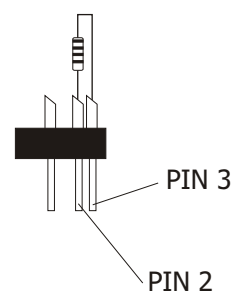

11.1-DMX Addresses

XR3000 SPOT CMY can be controlled with 30 (default) or 22 DMX channels.

If you want to use the unit in 30 channels mode (default), set the following addresses on the mixer:

Projector 1 A001

Projector 2 A031

If you want to select the next projector, just add "30"

Projector 3 A061

..... A....

projector 6 A151

11.2-Selecting the DMX address

1) Press the UP-DOWN key until you reach the required DMX channel. The numbers on the display will start to flash (but the new DMX address hasn't yet been set).

2) Press ENTER to confirm your selection. The numbers on the display will stop flashing and the projector is now setted to the new DMX address.

TRICKS:

if you keep pushed the UP or DOWN keys, the channels are calculated more quickly and you get a faster selection.

12 FIRMWARE UPDATING

Warning:

This procedure require a base knowelge of computer applications and Windows Hyperterminal program. **Please refer to an authorised D.T.S. service centre.**



To update the software version of the XR3000 SPOT CMY you need:

D.T.S. RED BOX interface (D.T.S. Code: 03.LA.008).

USB-DMX Driver for the D.T.S. RED BOX interface .

(The driver and the installation procedure are available in our web site www.dts-lighting.it)

Updating the software version.

Please follow the procedure below to perform the update:

1. Install the D.T.S. RED BOX USB-DMX driver on the PC you will use to update the unit software.
2. Connect the D.T.S. RED BOX interface to the PC by using a USB cable.
3. Connect the D.T.S. RED BOX interface to the fixture by using a DMX cable.
4. Download the new software version into the unit by using Windows Hyperterminal program.

It will be possible to download the software from the reserved area of D.T.S. web site:
www.dts-lighting.it.

13- DISPLAY FUNCTIONS

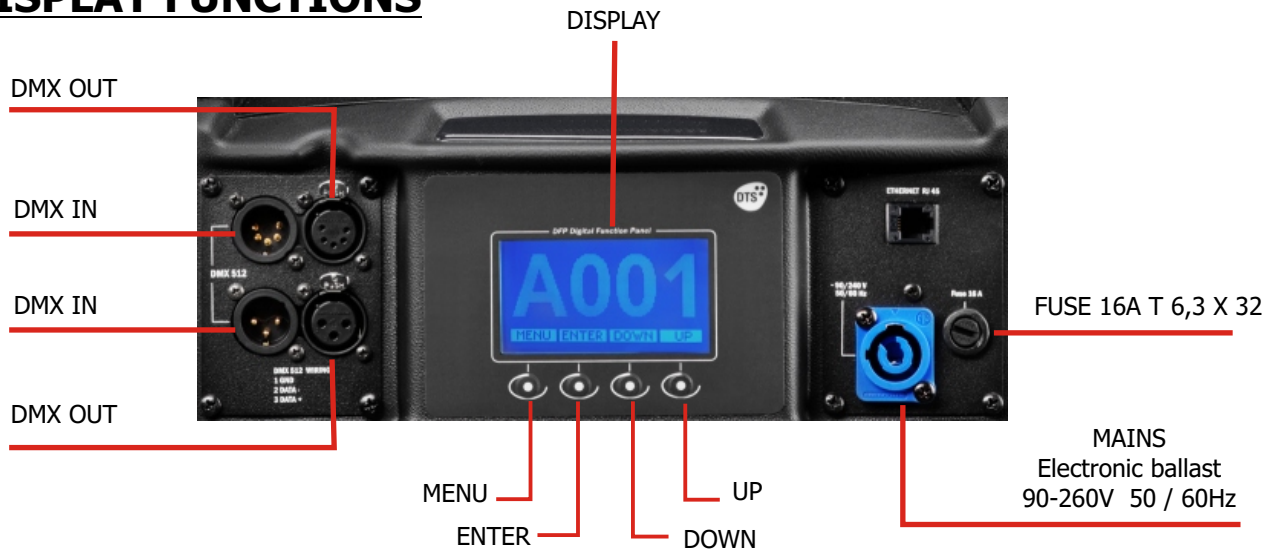

DISPLAY FUNCTIONS

The XR3000 SPOT CMY display panel shows all the available functions . Using these functions, it is possible to change some of the parameters and add some functions. Changing the D.T.S. setting can vary the functions of the unit so that it does not respond to the DMX 512 used to control it. Carefully follow the instructions below before carrying out any variations or selections.

NOTE: the symbol  shows which key has to be pushed to obtain the desired function.

  Pan Direction



Pan movement Normal or Reversed
Default = Normal



PAN DIRECTION
This menu allows to set the Pan movement.
Normal or Reversed

  Tilt Direction



Tilt movement Normal or Reversed
Default = Normal



TILT DIRECTION
This menu allows to set the Pan movement.
Normal or Reversed

  Pan Tilt Speed

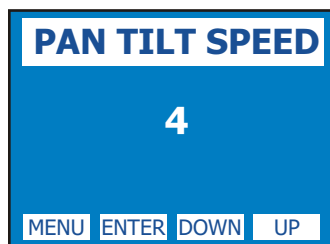

Pan Tilt Speed control
Default = 4



PAN TILT SPEED
Pan Tilt Speed control (1-4)

13- DISPLAY FUNCTIONS

Display

DISPLAY FLIP / STAND BY / CONTRAST

Display Flip:
Reverses display's reading depending on the mounting position
(On the ground or suspended).

Display Standby:
To turn off the display (after 5 seconds)
Or leave it always on.

Display Contrast:
Display contrast regulation (1-16)

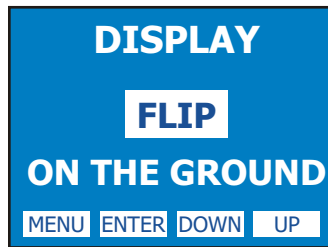

Display Flip
ON THE GROUND (Default)
SUSPENDED



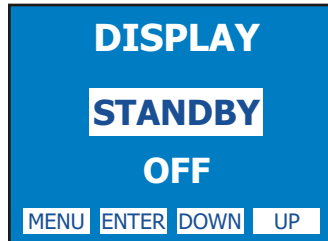

Display Standby
OFF = Display Standby disabled
(Default)
ON = Display goes OFF after 5 seconds



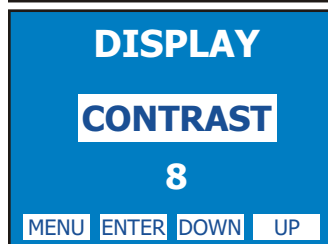

Display Contrast
1-16 (Default = 8)



DMX Mode

DMX MODE
To select DMX mode :
30 channels or 22 channels



DMX mode
30 channels (Default)
22 channels



Lamp

LAMP
Lamp always ON, always OFF,
lamp ON-OFF selectable via DMX
And lamp life time reset

ADJUST
To adjust the lamp with no mixer
connected.
It's possible to set the parameters for
PAN-TILT and ZOOM

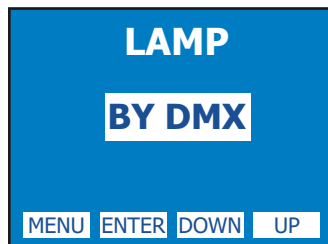

BY DMX = ON / OFF via DMX (default)
ALWAYS ON = Forced ON
ALWAYS OFF = Forced OFF
RESET COUNTER = Lamp life time
reset



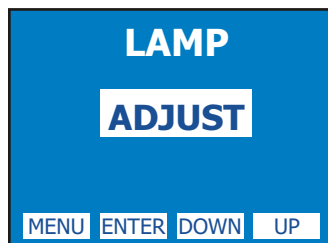

LAMP ADJUST = To adjust the lamp
with no mixer connected.
It's possible to set the parameters for
PAN-TILT and ZOOM



Reset

RESET
Reset via DMX ENABLED / DISABLED
and unit reset

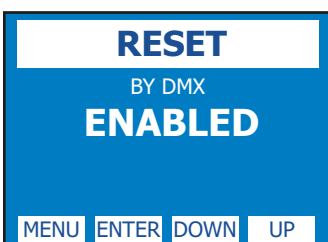

ENABLED = Reset via DMX enabled
(Default)
DISABLED = Reset via DMX disabled
NOW = Unit motors reset



13- DISPLAY FUNCTIONS

  Fan Speed

FAN SPEED
Fan Speed control

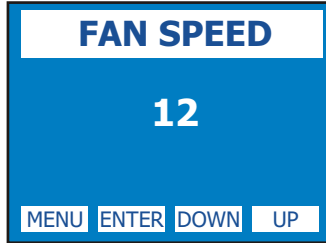

Fan speed control
1-12 (Default = 12)

ENTER

  Auto Focus

AUTO FUCOS
Automatic focusing

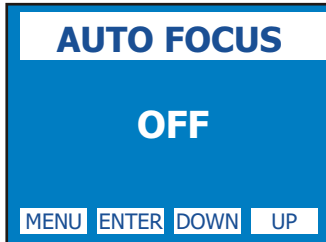

ON
OFF = (Default)

ENTER

  Gobo Rotation

GOBO ROTATION
Gobo rotation control the Rotating speed of gobo

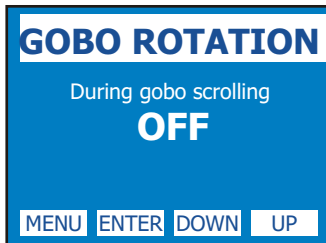

ON
OFF = (Default)

ENTER

  CMY Blackout

CMY BLACKOUT
CMY filters blades inserted at 100% if the dimmer remain closed for more than 5 seconds.
By activating this function, it will be possible to reduce substantially any visible light reflection coming out from the front lens when dimmer is closed.

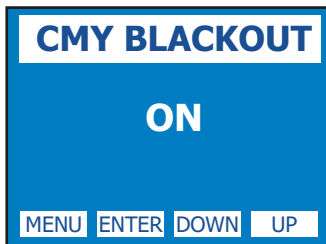

ON = Blackout enabled (Default)
OFF = Blackout disabled

ENTER

  System info

SYSTEM INFO
Lamp life time, lamp strikes, unit life time, 8 motors card software version, Pan&Tilt card software version and unit model

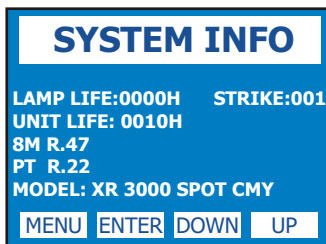

SYSTEM INFO
Lamp life time, lamp strikes, unit life time, 8 motors card software version, Pan&Tilt card software version and unit model

ENTER

  Reserved

RESERVED
Pan lock-Tilt lock
Pan free-Tilt free
System Reboot
(Code = 100)

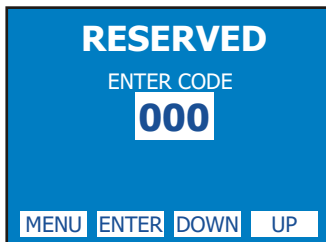

Pan Lock = Lock the Pan to the desired value
Tilt Lock = Lock the Tilt to the desired value
Pan Free = Remove power to Pan motor

ENTER

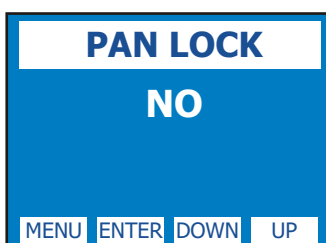

Tilt Free = Remove power to Tilt motor
System Reboot = Unit Reboot without needing of turning OFF the unit

13- DISPLAY FUNCTIONS



Default

DEFAULT
To restore main settings



Default
To restore main settings

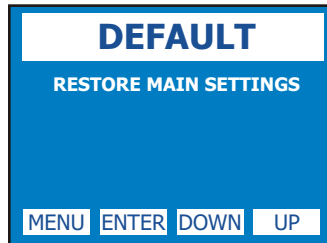

14- ERROR MESSAGES



COLOUR WHEEL
POSITION ERROR

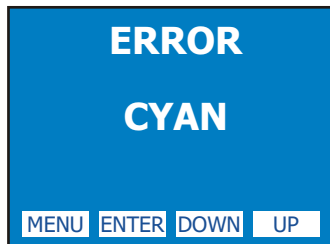

CYAN POSITION ERROR

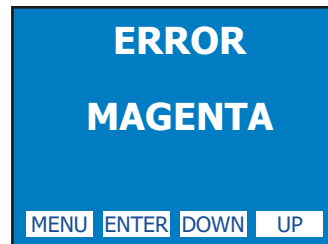

MAGENTA POSITION
ERROR

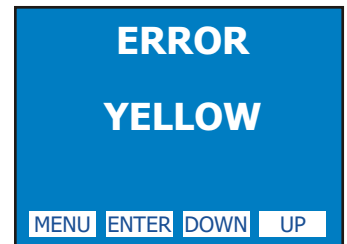

YELLOW POSITION
ERROR

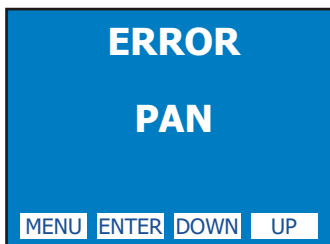

PAN REPOSITIONING
ENCODER ERROR

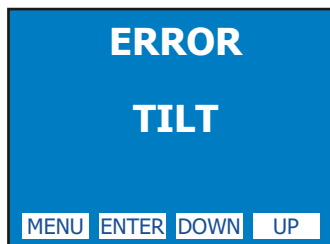

TILT REPOSITIONING
ENCODER ERROR

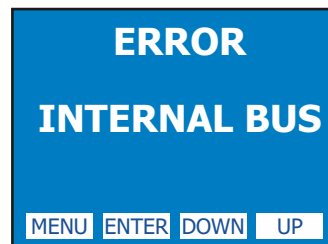

COMMUNICATION
PROBLEM BETWEEN 8
MOTORS CARD AND
PAN&TILT CARD

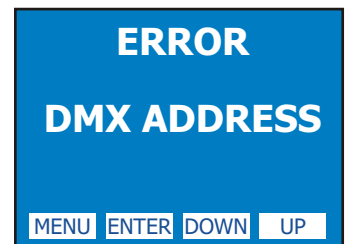

DMX ADDRESS
ERROR

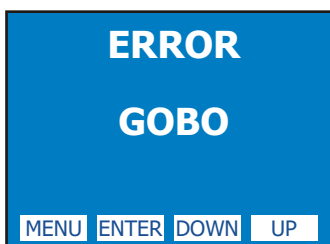

GOBO WHEEL ERROR

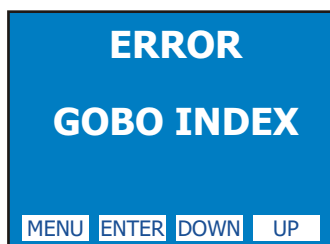

GOBO POSITION
ERROR

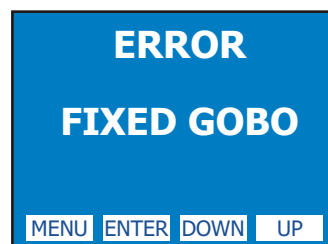

FIXED GOBO WHEEL
ERROR

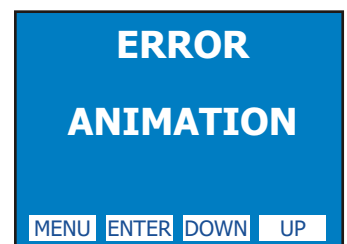

ANIMATION WHEEL
ERROR

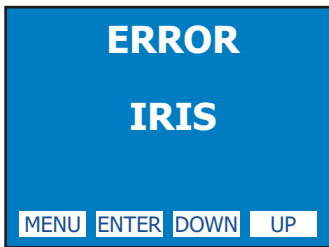

IRIS ERROR

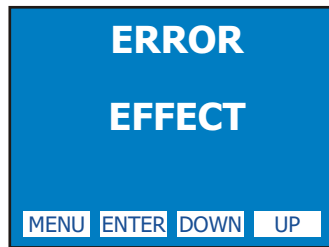

EFFECT WHEEL ERROR

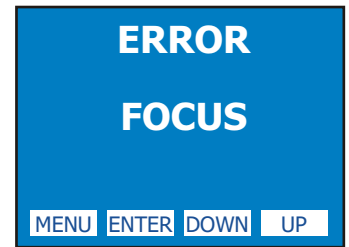

FOCUS ERROR

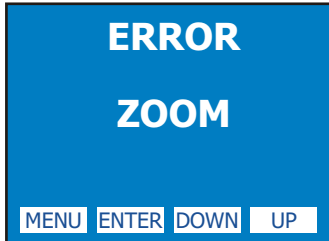

ZOOM ERROR

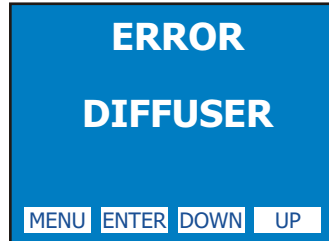

DIFFUSER ERROR

15- HIDDEN MENU

For technical personnel only.

To operate this menu:

-Connect the projector to the DMX controller (DMX SIGNAL MUST BE CORRECTLY RECEIVED)

- Reset the XR3000 SPOT CMY (reset from the MENU, not from the DMX controller!).
- While reset is running, press the MENU and ENTER keys at the same time.



ELECTRONIC
CALIBRATION OF THE
MOTORS

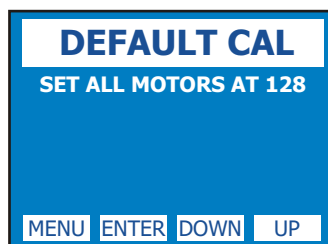

RESET EEPROM.
RESET ALL SETTINGS
TO 128 VALUE



FAN SPEED WHEN
DIMMER CLOSED

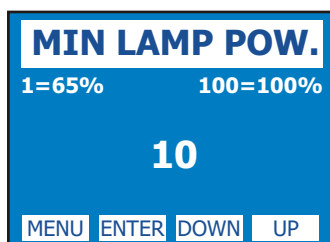

LAMP POWER WHEN
DIMMER CLOSED



EXIT FROM HIDDEN
MENU

15.1 Calibration

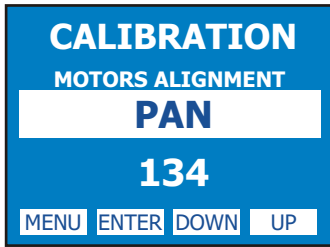

PAN ALIGNMENT
To align Pan position

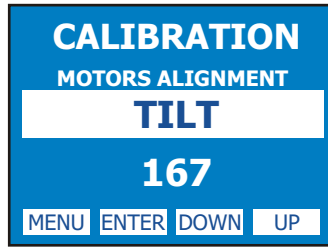

TILT ALIGNMENT
To align Tilt position



SHUTTER ALIGNMENT
To align Shutter blades



COLOUR WHEEL ALIGNMENT
To align Colour wheel



CYAN ZERO ALIGNMENT
Cyan zero position setting



CYAN PATH ALIGNMENT
Cyan excursion setting

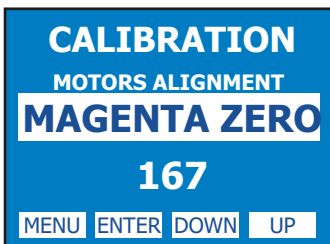

MAGENTA ZERO ALIGNMENT
Magenta zero position setting



MAGENTA PATH ALIGNMENT
Magenta excursion setting



YELLOW ZERO ALIGNMENT
Yellow zero position setting



YELLOW PATH ALIGNMENT
Yellow excursion setting



GOBO WHEEL ALIGNMENT
To align Gobo wheel



GOBO WHEEL INDEX ALIGNMENT
To align Gobo wheel Index



GOBO FIXED WHEEL
ALIGNMENT
To align Gobo wheel

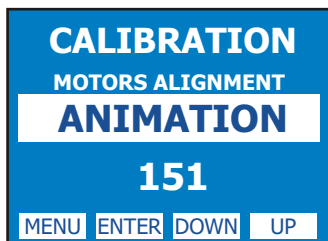

ANIMATION WHELL ALIGNMENT
To align ANIMATION WHEEL

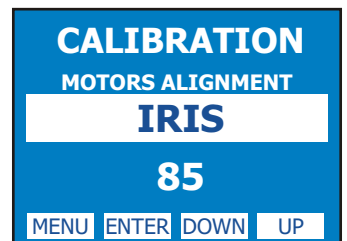

IRIS ALIGNMENT
To align IRIS

Calibration mode

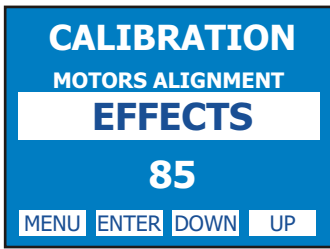

EFFECTS ALIGNMENT
To align EFFECTS

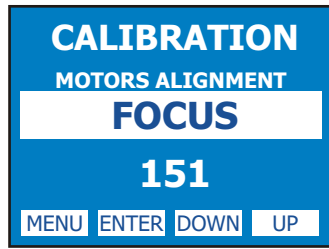

FOCUS ALIGNMENT
To align FOCUS

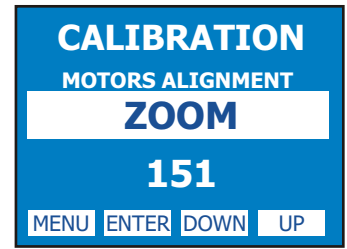

ZOOM ALIGNMENT
To align ZOOM

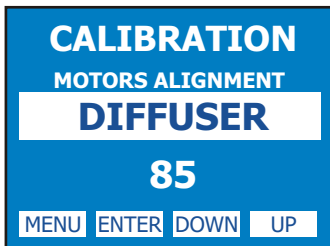

DIFFUSER ALIGNMENT
To align DIFFUSER

16- PAN & TILT SPEED (default: 4)

You can set the PAN and TILT motors at high speed on your XR3000 SPOT CMY.

Press menu until you see PAN TILT SPEED.

Press ENTER and select a speed with UP-DOWN (there are 4 speeds). Confirm by pressing ENTER.

17- FAN SPEED (default: 5)

Fan speed regulation makes it possible to reduce fan noise. However, the ambient temperature must be less than 35° C.

18- OPENING THE PROJECTOR HOUSING

It is possible to inspect the inside of the projector by removing the cover as indicated below.

ATTENTION

REMOVE MAINS POWER PRIOR TO ACCESSING THE PROJECTOR'S INTERNAL COMPONENTS.

- 1) Loosen the 3 screws which fix the head covers (photo 1) .
- 2) Once unscrewed, simply lift the covers to access the internal components (photo 2).



Photo 1



Photo 2

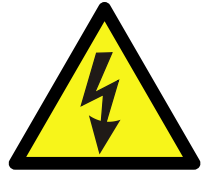

19- REPLACING GOBOS

XR3000 SPOT CMY uses a mechanical system which allows the fixture's gobos to be removed without the use of special tools. Replacement gobos should be made of either heat resistant glass or metal. An ever-increasing range of gobos is available from your D.T.S. sales network.

Gobo dimensions are as follows:

ø external (ED) = 27.9 mm

ø of image with defined edge (ID) = 24 mm

thickness = from 0.2 to 4 mm (see catalogue)

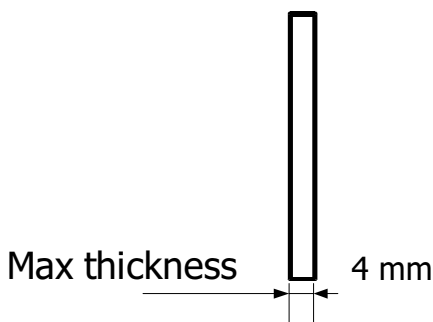

Coated side

When an object is held up the coated side of the glass gobo there is no space between the object and its reflection.



Coated side

Uncoated side

When an object is held up the uncoated side of the glass gobo there is a space between the object and its reflection.



Uncoated side

Load with coated surface toward the light source.

Replacing gobos on the rotating gobo wheel

When replacing gobos, ensure that the projector is switched off.

- 1) Open the projector housing as described on page 21.
- 2) Remove the gobo holder to allow easier access to the gobo (photo 1).
- 3) Release the gobo retaining spring and carefully remove the gobo (photo 2).
- 4) Reverse the procedure to install a replacement gobo.

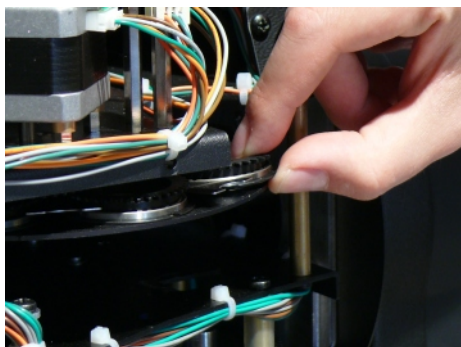

Photo 1

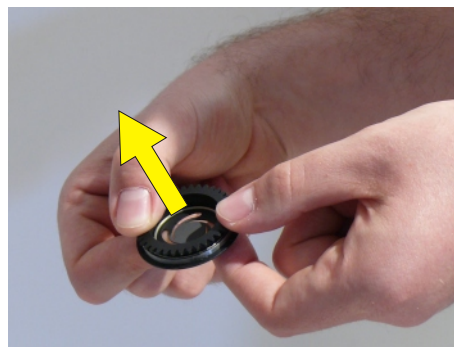

Photo 2

20- PERIODIC CLEANING

20.1- Lenses and reflectors

Even a fine layer of dust can reduce the luminous output substantially. Regularly clean all lenses and the reflector using a soft cotton cloth, dampened with a specialist lens cleaning solution.

20.2- Fans and air passages

The fans and air passages must be cleaned approximately every 6 weeks. This periodic cleaning will depend of course, on the conditions in which the projector is operating. Suitable instruments for performing this type of maintenance are a brush and a common vacuum cleaner or an air compressor. If necessary, clean the fans and air passages more frequently.

21- PERIODIC CONTROLS

Attention

Disconnect mains power prior to removing the projector housing.



Lamp

The lamp should be replaced if there is any visible damage or deformation due to heat. This will help to avoid the danger of the lamp exploding.

XR3000 SPOT CMY lamp lifespan is about 750 hours, then it is necessary to replace it.

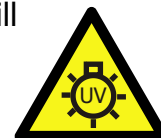

Mechanical parts

Periodically check all mechanical parts, gears, guides, belts, etc. for wear and tear, replacing them if necessary. Periodically check the lubrication of all components, particularly the parts subject to high temperatures. If necessary, lubricate with suitable lubricant, available from your D.T.S. distributor. Check the tension of the belts and adjust it if necessary.

Electrical components

Check all electrical components for correct earthing and proper connection of all connectors, refastening if necessary.

Fuse replacement

Locate the fuse, which protects the lamp and electronics, in the base of the XR3000 SPOT CMY. Using a multimeter, test the condition of the fuse, replacing it with one of equivalent type if necessary.

22- DMX PROTOCOL**30 CHANNELS MODE (DEFAULT)**

- 1 PAN msb 540°**
- 2 PAN lsb**
- 3 TILT msb 270°**
- 4 TILT lsb**
- 5 SPEED MOVEMENT**
- 6 DIMMER**
- 7 SHUTTER**
- 8 COLOUR**
- 9 COLOUR MODE**
- 10 CYAN**
- 11 MAGENTA**
- 12 YELLOW**
- 13 SPEED CMY**
- 14 MACRO CMY**
- 15 GOBO**
- 16 GOBO MODE**
- 17 GOBO ROTATION/INDEX**
- 18 GOBO INDEX FINE**
- 19 GOBO SHAKE**
- 20 FIXED GOBO**
- 21 FIXED GOBO ROTATION**
- 22 ANIMATION**
- 23 ANIMATION ROTATION**
- 24 IRIS**
- 25 IRIS MACRO**
- 26 EFFECT**
- 27 EFFECTS ROTATION**
- 28 FOCUS**
- 29 ZOOM**
- 30 RESET/LAMP**

DMX CHANNEL	1	Parameter: PAN msb
-------------	----------	---------------------------

DMX CHANNEL	2	Parameter: PAN lsb
-------------	----------	---------------------------

DMX CHANNEL	3	Parameter: TILT msb
-------------	----------	----------------------------

DMX CHANNEL	4	Parameter: TILT lsb
-------------	----------	----------------------------

DMX CHANNEL	5	Parameter: SPEED MOVEMENT
-------------	----------	----------------------------------

DMX range Value	Mid point DMX value	Move range (degrees)	Mode	Option	Function
000-010					Standard
011-025					Fast movement
026-127					Vector mode from fast to slow
128-247					Variable time reaction to DMX signal (fast to slow)
248-255					Silent Mode

DMX CHANNEL	6	Parameter: DIMMER
-------------	---	--------------------------

DMX range Value	Mid point DMX value	Move range (degrees)	Mode	Option	Function
000-007					Black-out
008-255					Proportional dimmer

DMX CHANNEL	7	Parameter: SHUTTER
-------------	---	---------------------------

DMX range Value	Mid point DMX value	Move range (degrees)	Mode	Option	Function
000-019					Black-out
020-039					Open
040-059					Black-out
060-079					Random Strobe
080-089					Strobe speed 1 min. (0,85 Hz)
090-099					Strobe speed 2 (1,4 Hz)
100-109					Strobe speed 3 (2 HZ)
110-119					Strobe speed 4 (3,75 Hz)
120-129					Strobe speed 5 (5 Hz)
130-139					Strobe speed 6 max. (6,75 Hz)
140-149					Pulse open speed 1 min.
150-159					Pulse open speed 2
160-169					Pulse open speed 3
170-179					Pulse open speed 4 max.
180-189					Pulse closed speed 1 min.
190-199					Pulse closed speed 2
200-209					Pulse closed speed 3
210-219					Pulse closed speed 4 max.
220-227					Colour and Gobo in black-out
228-233					Pan and Tilt in black-out
234-255					Open

DMX CHANNEL	8	Parameter: COLOUR
-------------	---	--------------------------

DMX range Value	Mid point DMX value	Move range (degrees)	Mode	Option	Function
000-031					Colour 1
032-063					Colour 2
064-095					Colour 3
096-127					Colour 4
128-159					Colour 5
160-191					Colour 6
192-223					Colour 7
224-255					Colour 8

DMX CHANNEL	8	Parameter: COLOUR
-------------	----------	--------------------------

DMX range Value	Mid point DMX value	Move range (degrees)	Mode	Option	Function
IF CHANNEL 9 = HALF COLOUR (DMX range value 64 - 127)					
000-027					Colour 1
028-055					Bicolour 1/ 2
056-083					Bicolour 2/ 3
084-111					Bicolour 3/ 4
112-139					Bicolour 4/ 5
140-167					Bicolour 5/ 6
168-195					Bicolour 6/ 7
196-223					Bicolour 7/ 8
224-255					Bicolour 8/ 1

IF CHANNEL 9 = PROPORTIONAL COLOUR (DMX range value 128 - 191)					
000-010					No Colour
011-255					Proportional colour

IF CHANNEL 9 = PROPOTIONALL RAINBOW (DMX range value 192 - 255)					
000-009					No Colour
010-127					CW Rot.Speed from Max to Min
128-137					Stop
138-255					CCW Rot.speed from Min to Max

DMX CHANNEL	9	Parameter: COLOUR MODE
-------------	----------	-------------------------------

DMX range Value	Mid point DMX value	Move range (degrees)	Mode	Option	Function
000-063					Full Colour
064-127					Half Colour
128-191					Proportional Colour
192-255					Propotional Rainbow

DMX CHANNEL	10	Parameter: CYAN
-------------	-----------	------------------------

DMX range Value	Mid point DMX value	Move range (degrees)	Mode	Option	Function
000-255					Propotional colour

DMX CHANNEL	11	Parameter: MAGENTA
-------------	-----------	---------------------------

DMX range Value	Mid point DMX value	Move range (degrees)	Mode	Option	Function
000-255					Propotional colour

DMX CHANNEL	12	Parameter: YELLOW
-------------	-----------	--------------------------

DMX range Value	Mid point DMX value	Move range (degrees)	Mode	Option	Function
000-255					Proportional colour

DMX CHANNEL	13	Parameter: SPEED CMY
-------------	-----------	-----------------------------

DMX range Value	Mid point DMX value	Move range (degrees)	Mode	Option	Function
000-007					No function
008-255					Variable speed from max to min

DMX CHANNEL	14	Parameter: MACRO CMY
-------------	-----------	-----------------------------

DMX range Value	Mid point DMX value	Move range (degrees)	Mode	Option	Function
000-009					No function
010-014					Macro1
015-019					Macro2
020-024					Macro3
025-029					Macro4
030-034					Macro5
035-039					Macro6
040-044					Macro7
045-049					Macro8
050-054					Macro9
055-059					Macro10
060-064					Macro11
065-069					Macro12
070-074					Macro13
075-079					Macro14
080-084					Macro15
085-089					Macro16
090-094					Macro17
095-099					Macro18
100-104					Macro19
105-109					Macro20
110-114					Macro21
115-121					Macro rainbow wait=0
122-128					Macro rainbow wait=2
129-135					Macro rainbow wait=3
136-142					Macro rainbow wait=4
143-149					Macro rainbow wait=5
150-156					Macro rainbow wait=6
157-163					Macro rainbow wait=7
164-170					Macro rainbow wait=8

DMX CHANNEL		14	Parameter: MACRO CMY		
DMX range Value	Mid point DMX value	Move range (degrees)	Mode	Option	Function
171-177					Macro rainbow wait=9
178-185					Macro rainbow wait=10
186-192					Full colours rainbow wait=0
193-199					Full colours rainbow wait=2
200-206					Full colours rainbow wait=3
207-213					Full colours rainbow wait=4
214-220					Full colours rainbow wait=5
221-227					Full colours rainbow wait=6
228-234					Full colours rainbow wait=7
235-241					Full colours rainbow wait=8
242-248					Full colours rainbow wait=9
249-255					Full colours rainbow wait=10

DMX CHANNEL		15	Parameter: GOBO 1		
-------------	--	----	--------------------------	--	--

DMX range Value	Mid point DMX value	Move range (degrees)	Mode	Option	Function
000-025					Open
026-051					Gobo 1
052-077					Gobo 2
078-103					Gobo 3
104-129					Gobo 4
130-155					Gobo 5
156-181					Gobo 6
182-207					Gobo 7
208-213					Speed rotation 1 min.
214-219					Speed rotation 2
220-225					Speed rotation 3
226-231					Speed rotation 4
232-237					Speed rotation 5
238-243					Speed rotation 6
244-249					Speed rotation 7
250-255					Speed rotation 8 max

DMX CHANNEL		16	Parameter: GOBO MODE		
-------------	--	----	-----------------------------	--	--

DMX range Value	Mid point DMX value	Move range (degrees)	Mode	Option	Function
000-127					Gobo rotation mode
128-255					Gobo index mode

DMX CHANNEL	17	Parameter: GOBO 1 ROTATION/GOBO 1 INDEX COARSE
-------------	----	---

DMX range Value	Mid point DMX value	Move range (degrees)	Mode	Option	Function
IF CHANNEL 16 = Gobo Rotation Mode (Dmx range value 0 - 127)					
000-009					Stop
010-127					CCW Rot. Prop. Speed Max to Min
128-137					Stop
138-255					CW Rot. Prop. Speed Min to Max
IF CHANNEL 16 = Gobo Index Mode (Dmx range value 128 - 255)					
000-255					Gobo index Coarse

DMX CHANNEL	18	Parameter: GOBO 1 INDEX FINE
-------------	----	-------------------------------------

DMX range Value	Mid point DMX value	Move range (degrees)	Mode	Option	Function
000-255					Gobo Index Fine

DMX CHANNEL	19	Parameter: GOBO 1 SHAKE
-------------	----	--------------------------------

DMX range Value	Mid point DMX value	Move range (degrees)	Mode	Option	Function
000-009					Stop
010-022					Gobo Shake R-L Speed 1 Min.
023-035					Gobo Shake R-L Speed 2
036-048					Gobo Shake R-L Speed 3
049-061					Gobo Shake R-L Speed 4
062-074					Gobo Shake R-L Speed 5
075-087					Gobo Shake R-L Speed 6
088-100					Gobo Shake R-L Speed 7
101-113					Gobo Shake R-L Speed 8
114-126					Gobo Shake R-L Speed 9 Max
127-138					Stop
139-151					Gobo Shake L-R Speed 1 Min
152-164					Gobo Shake L-R Speed 2
165-177					Gobo Shake L-R Speed 3
178-190					Gobo Shake L-R Speed 4
191-203					Gobo Shake L-R Speed 5
204-216					Gobo Shake L-R Speed 6
217-229					Gobo Shake L-R Speed 7
230-242					Gobo Shake L-R Speed 8
243-255					Gobo Shake L-R Speed 9 Max

DMX CHANNEL	20	Parameter: FIXED GOBO
-------------	----	------------------------------

DMX range Value	Mid point DMX value	Move range (degrees)	Mode	Option	Function
000-022					Open
023-045					Gobo 1
046-068					Gobo 2
069-091					Gobo 3
092-114					Gobo 4
115-137					Gobo 5
138-160					Gobo 6
161-183					Gobo 7
184-207					Gobo 8
208-213					Speed rotation 1 min
214-219					Speed rotation 2
220-225					Speed rotation 3
226-231					Speed rotation 4
232-237					Speed rotation 5
238-243					Speed rotation 6
244-255					Speed rotation 7 max

DMX CHANNEL	21	Parameter: FIXED GOBO SHAKE
-------------	----	------------------------------------

DMX range Value	Mid point DMX value	Move range (degrees)	Mode	Option	Function
000-009					Stop
010-022					Gobo Shake R-L Speed 1 Min.
023-035					Gobo Shake R-L Speed 2
036-048					Gobo Shake R-L Speed 3
049-061					Gobo Shake R-L Speed 4
062-074					Gobo Shake R-L Speed 5
075-087					Gobo Shake R-L Speed 6
088-100					Gobo Shake R-L Speed 7
101-113					Gobo Shake R-L Speed 8
114-126					Gobo Shake R-L Speed 9 Max
127-138					Stop
139-151					Gobo Shake L-R Speed 1 Min
152-164					Gobo Shake L-R Speed 2
165-177					Gobo Shake L-R Speed 3
178-190					Gobo Shake L-R Speed 4
191-203					Gobo Shake L-R Speed 5
204-216					Gobo Shake L-R Speed 6
217-229					Gobo Shake L-R Speed 7
230-242					Gobo Shake L-R Speed 8
243-255					Gobo Shake L-R Speed 9 Max

DMX CHANNEL	22	Parameter: ANIMATION
-------------	-----------	-----------------------------

DMX range Value	Mid point DMX value	Move range (degrees)	Mode	Option	Function
000-009					No function
010-255					Linear animation position

DMX CHANNEL	23	Parameter: ANIMATION ROTATION
-------------	-----------	--------------------------------------

DMX range Value	Mid point DMX value	Move range (degrees)	Mode	Option	Function
000-009					Stop
010-127					CCW rotation from fast to slow
128-137					Stop
138-255					CW rotation from fast to slow

DMX CHANNEL	24	Parameter: IRIS
-------------	-----------	------------------------

DMX range Value	Mid point DMX value	Move range (degrees)	Mode	Option	Function
000-009					Open
010-246					Linear Iris from Open to Closed
247-255					Closed

DMX CHANNEL	25	Parameter: IRIS MACROS
-------------	-----------	-------------------------------

DMX range Value	Mid point DMX value	Move range (degrees)	Mode	Option	Function
000-009					No effect
010-063					Iris pulse at different speed from Min to Max
064-117					Iris pulse with flash closing from Min to Max
118-171					Iris pulse with flash opening from Min to Max
172-213					Iris pulse with flash closing combined with zoom from Min to Max
214-255					Iris pulse with flash opening combined with zoom from Min to Max

DMX CHANNEL	26	Parameter: EFFECTS
-------------	-----------	---------------------------

DMX range Value	Mid point DMX value	Move range (degrees)	Mode	Option	Function
000-050					No effect
051-085					Diffuser
086-171					Prism
172-255					Frost

DMX CHANNEL	27	Parameter: EFFECTS ROTATION
-------------	-----------	------------------------------------

DMX range Value	Mid point DMX value	Move range (degrees)	Mode	Option	Function
000-009					Stop
010-127					CCW Rotation from fast to slow
128-143					Stop
144-255					CW Rotation from slow to fast

DMX CHANNEL	28	Parameter: FOCUS
-------------	-----------	-------------------------

DMX range Value	Mid point DMX value	Move range (degrees)	Mode	Option	Function
000-255					Linear focus (1m to -∞)

DMX CHANNEL	29	Parameter: ZOOM
-------------	-----------	------------------------

DMX range Value	Mid point DMX value	Move range (degrees)	Mode	Option	Function
000-255					Linear zoom from 8° to 30°

DMX CHANNEL	30	Parameter: RESET
-------------	-----------	-------------------------

DMX range Value	Mid point DMX value	Move range (degrees)	Mode	Option	Function
000-009					No Effect
010-060					Lamp OFF (activ.after 3 seconds)
061-129					No Effect
130-179					Lamp ON (activ.after 3 seconds)
180-200					No Effect
201-239					Internal motor reset
240-255					Total Reset

22 CHANNELS MODE

1	PAN msb 540°
2	PAN lsb
3	TILT msb 270°
4	TILT lsb
5	SPEED MOVEMENT
6	DIMMER
7	SHUTTER
8	COLOUR
9	CYAN
10	MAGENTA
11	YELLOW
12	GOBO
13	GOBO ROTATION/INDEX
14	FIXED GOBO
15	ANIMATION
16	ANIMATION ROTATION
17	IRIS
18	EFFECTS
19	EFFECTS ROTATION
20	FOCUS
21	ZOOM
22	LAMP ON/OFF - RESET

DMX CHANNEL	1	Parameter: PAN msb
-------------	----------	---------------------------

DMX CHANNEL	2	Parameter: PAN lsb
-------------	----------	---------------------------

DMX CHANNEL	3	Parameter: TILT msb
-------------	----------	----------------------------

DMX CHANNEL	4	Parameter: TILT lsb
-------------	----------	----------------------------

DMX CHANNEL	5	Parameter: SPEED MOVEMENT
-------------	----------	----------------------------------

DMX range Value	Mid point DMX value	Move range (degrees)	Mode	Option	Function
000-010					Standard
011-025					Fast movement
026-127					Vector mode from fast to slow
128-247					Variable time reaction to DMX signal (fast to slow)
248-255					Silent Mode

DMX CHANNEL	6	Parameter: DIMMER
-------------	---	--------------------------

DMX range Value	Mid point DMX value	Move range (degrees)	Mode	Option	Function
000-007					Black-out
008-255					Proportional dimmer

DMX CHANNEL	7	Parameter: SHUTTER
-------------	---	---------------------------

DMX range Value	Mid point DMX value	Move range (degrees)	Mode	Option	Function
0-19					Black-out
20-39					Open
40-59					Black-out
60-79					Random Strobe
80-89					Strobe speed 1 min. (0,85 Hz)
90-99					Strobe speed 2 (1,4 Hz)
100-109					Strobe speed 3 (2 HZ)
110-119					Strobe speed 4 (3,75 Hz)
120-129					Strobe speed 5 (5 Hz)
130-139					Strobe speed 6 max. (6,75 Hz)
140-149					Pulse open speed 1 min.
150-159					Pulse open speed 2
160-169					Pulse open speed 3
170-179					Pulse open speed 4 max.
180-189					Pulse closed speed 1 min.
190-199					Pulse closed speed 2
200-209					Pulse closed speed 3
210-219					Pulse closed speed 4 max.
220-227					Colour and Gobo in black-out
228-233					Pan and Tilt in black-out
234-255					Open

DMX CHANNEL	8	Parameter: COLOUR 1
-------------	---	----------------------------

DMX range Value	Mid point DMX value	Move range (degrees)	Mode	Option	Function
000-011					Colour 1
012-023					Colour 1-2
024-035					Colour 2
036-047					Colour 2-3
048-059					Colour 3
060-071					Colour 3-4
072-083					Colour 4
084-095					Colour 4-5
096-107					Colour 5
108-119					Colour 5-6
120-131					Colour 6
132-143					Colour 6-7

DMX CHANNEL	8	Parameter: COLOR
-------------	----------	-------------------------

DMX range Value	Mid point DMX value	Move range (degrees)	Mode	Option	Function
144-155					Colour 7
156-167					Colour 7-8
168-179					Colour 8
180-197					Colour 8-1
198-200					CW rotation speed 9 max.
201-203					CW rotation speed 8
204-206					CW rotation speed 7
207-209					CW rotation speed 6
210-212					CW rotation speed 5
213-215					CW rotation speed 4
216-218					CW rotation speed 3
219-221					CW rotation speed 2
222-224					CW rotation speed 1 min.
225-228					Stop
229-231					CCW rotation speed 1 min.
232-234					CCW rotation speed 2
235-237					CCW rotation speed 3
238-240					CCW rotation speed 4
241-243					CCW rotation speed 5
244-246					CCW rotation speed 6
247-249					CCW rotation speed 7
250-252					CCW rotation speed 8
253-255					CCW rotation speed 9 max.

DMX CHANNEL	9	Parameter: CYAN
-------------	----------	------------------------

DMX range Value	Mid point DMX value	Move range (degrees)	Mode	Option	Function
000-255					Proportional colour

DMX CHANNEL	10	Parameter: MAGENTA
-------------	-----------	---------------------------

DMX range Value	Mid point DMX value	Move range (degrees)	Mode	Option	Function
000-255					Proportional colour

DMX CHANNEL	11	Parameter: YELLOW
-------------	-----------	--------------------------

DMX range Value	Mid point DMX value	Move range (degrees)	Mode	Option	Function
000-255					Proportional colour

DMX CHANNEL	12	Parameter: GOBO
-------------	----	------------------------

DMX range Value	Mid point DMX value	Move range (degrees)	Mode	Option	Function
000-025					Open
026-051					Gobo 1
052-077					Gobo 2
078-103					Gobo 3
104-129					Gobo 4
130-155					Gobo 5
156-181					Gobo 6
182-207					Gobo 7
208-213					Speed rotation 1 min.
214-219					Speed rotation 2
220-225					Speed rotation 3
226-231					Speed rotation 4
232-237					Speed rotation 5
238-243					Speed rotation 6
244-249					Speed rotation 7
250-255					Speed rotation 8 max

DMX CHANNEL	13	Parameter: GOBO ROTATION/GOBO 1 INDEX COARSE
-------------	----	---

DMX range Value	Mid point DMX value	Move range (degrees)	Mode	Option	Function
000-127					Stop
128-180					CCW Rot. Prop. Speed Max to Min
181-202					Stop
203-255					CW Rot. Prop. Speed Min to Max

DMX CHANNEL	14	Parameter: FIXED GOBO
-------------	----	------------------------------

DMX range Value	Mid point DMX value	Move range (degrees)	Mode	Option	Function
000-022					Open
023-045					Gobo 1
046-068					Gobo 2
069-091					Gobo 3
092-114					Gobo 4
115-037					Gobo 5
138-160					Gobo 6
161-183					Gobo 7
184-207					Gobo 8
208-213					Speed rotation 1 min
214-219					Speed rotation 2
220-225					Speed rotation 3
226-231					Speed rotation 4
232-237					Speed rotation 5
238-243					Speed rotation 6
244-255					Speed rotation 7 max

DMX CHANNEL	15	Parameter: ANIMATION
-------------	-----------	-----------------------------

DMX range Value	Mid point DMX value	Move range (degrees)	Mode	Option	Function
000-009					No function
010-255					Linear animation position

DMX CHANNEL	16	Parameter: ANIMATION ROTATION
-------------	-----------	--------------------------------------

DMX range Value	Mid point DMX value	Move range (degrees)	Mode	Option	Function
000-009					Stop
010-127					CCW rotation from fast to slow
128-137					Stop
138-255					CW rotation from fast to slow

DMX CHANNEL	17	Parameter: IRIS
-------------	-----------	------------------------

DMX range Value	Mid point DMX value	Move range (degrees)	Mode	Option	Function
000-009					Open
010-124					Linear Iris from Open to Closed
125-132					Closed
133-159					Iris pulse at different speed from Min to Max
160-186					Iris pulse with flash closing from Min to Max
187-213					Iris pulse with flash opening from Min to Max
214-234					Iris pulse with flash closing combined with zoom from Min to Max
235-255					Iris pulse with flash opening combined with zoom from Min to Max

DMX CHANNEL	18	Parameter: EFFECTS
-------------	-----------	---------------------------

DMX range Value	Mid point DMX value	Move range (degrees)	Mode	Option	Function
000-050					No effect
051-085					Diffuser
086-171					Prism
172-255					Frost

DMX CHANNEL	19	Parameter: EFFECTS ROTATION
-------------	-----------	------------------------------------

DMX range Value	Mid point DMX value	Move range (degrees)	Mode	Option	Function
000-009					Stop
010-127					CCW Rotation from fast to slow
128-143					Stop
144-255					CW Rotation from slow to fast

DMX CHANNEL	20	Parameter: FOCUS
-------------	-----------	-------------------------

DMX range Value	Mid point DMX value	Move range (degrees)	Mode	Option	Function
000-255					Linear focus (1m to -∞)

DMX CHANNEL	21	Parameter: ZOOM
-------------	-----------	------------------------

DMX range Value	Mid point DMX value	Move range (degrees)	Mode	Option	Function
000-255					Linear zoom from 8° to 30°

DMX CHANNEL	22	Parameter: RESET / LAMP
-------------	-----------	--------------------------------

DMX range Value	Mid point DMX value	Move range (degrees)	Mode	Option	Function
000-009					No Effect
010-060					Lamp OFF (activ.after 3 seconds)
061-129					No Effect
130-179					Lamp ON (activ.after 3 seconds)
180-200					No Effect
201-239					Internal motor reset
240-255					Total Reset

23- 8 MOTORS CONTROL CARD

8 MOTORS CONTROL CARD

J7 Magnetic Sensors Connector

Line 1 Brown
Line 2 Orange

GND
ORANGE
BROWN
VCC

J26 to 6 Motors
Control card

J9 from J3 Lamp ON-OFF
control card

J1 Internal DATA
Communication
Connector
From J8 Pan & Tilt
card

30 VDC

Fans

Fans

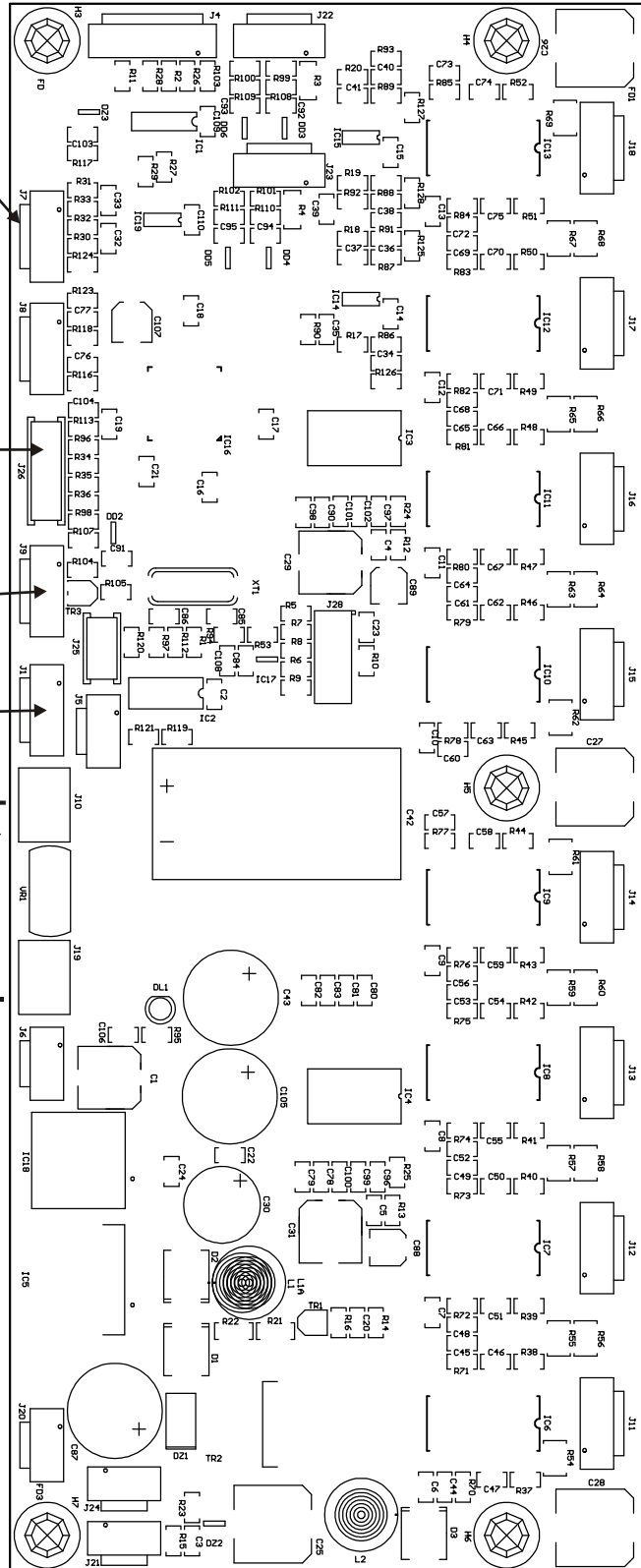

Rotating gobo wheel
(BLACK)

Fixed gobo wheel
(DARK GREEN)

Strobe
(YELLOW)

Animation
(PINK)

Colour
(GREY)

Magenta
(LIGHT BLUE)

Cyan
(Gold)

Yellow
(LIGHT BLUE)

24- 8 MOTORS SLAVE CONTROL CARD

Rot Animation
(YELLOW LINE)

Diffuser
(VIOLET LINE)

J1 from 8
Motors
Control card

GND
RES LINE 3
RES LINE 3
+5V

+

30 VDC

—

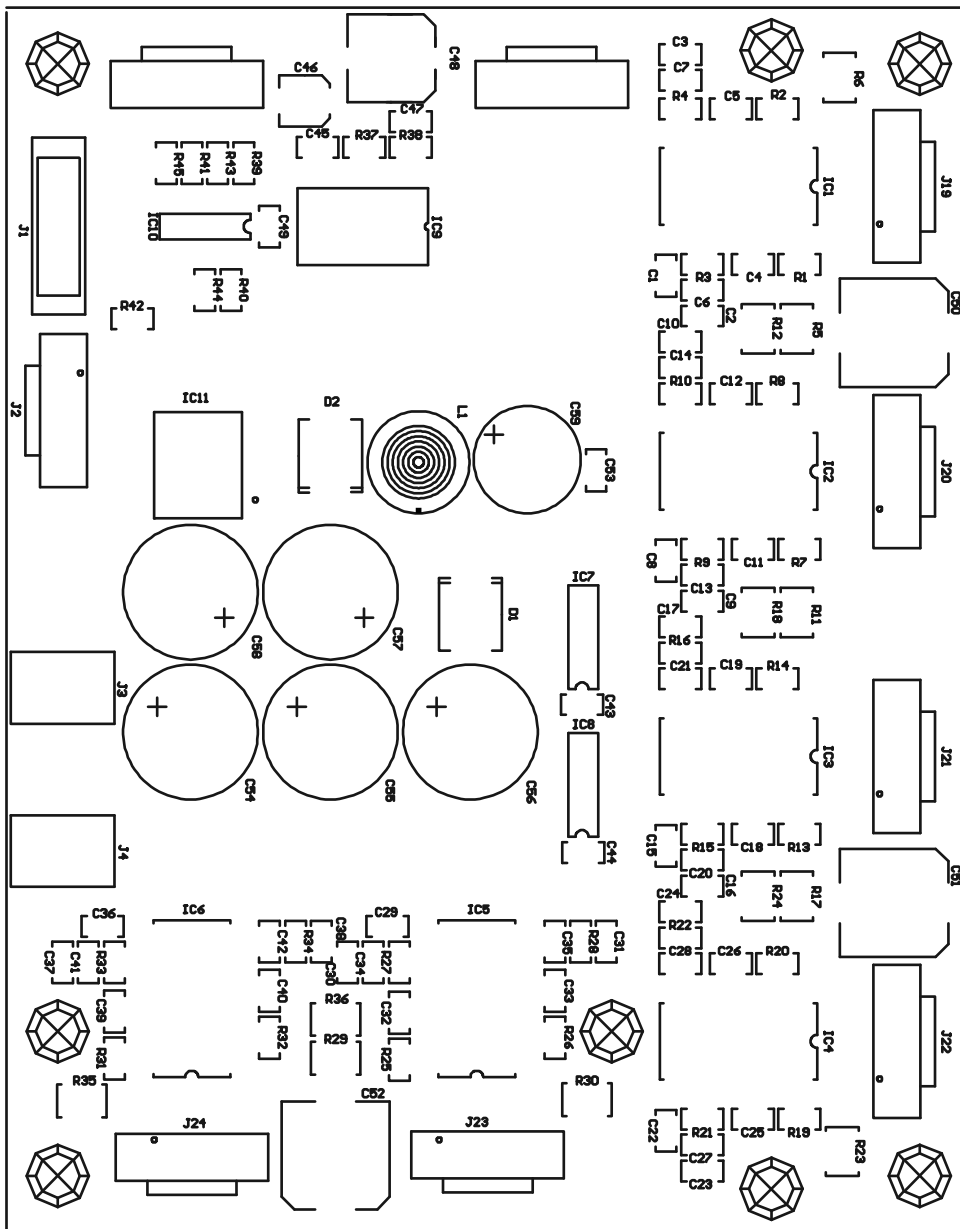

Iris
(RED)

Effect rotation
(DARK ORANGE)

Effects
(LIGHT ORANGE)

Gobo rotation
(BROWN)

Zoom
(YELLOW)

Focus
(VIOLET)

25-PAN & TILT CARD

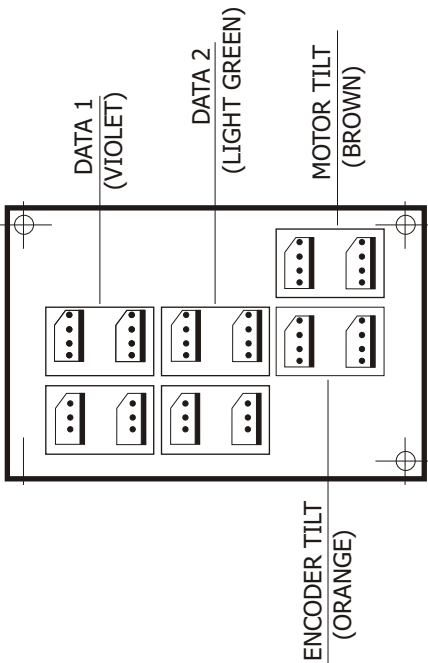
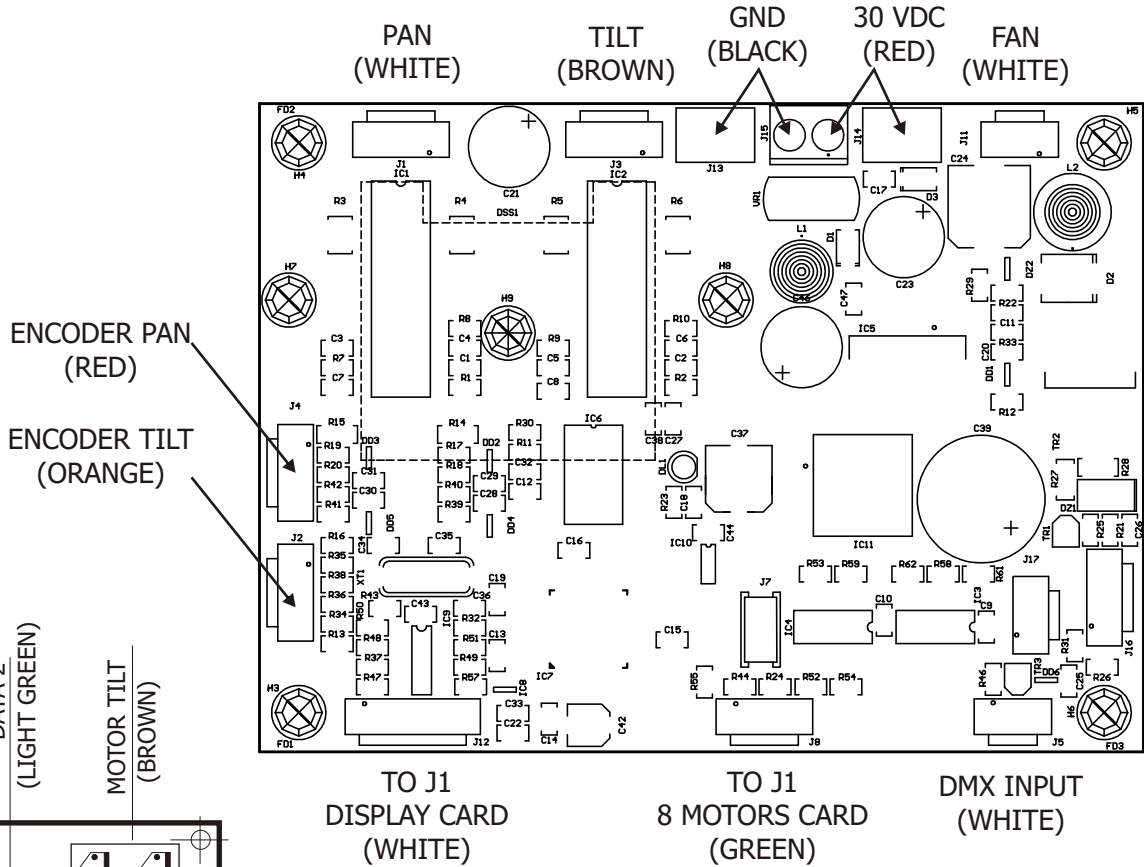

26-CABLES RESEND CARD

27-DISPLAY CARD

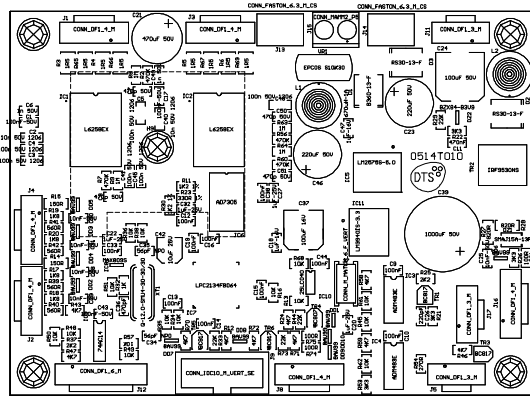

28-LAMP ON-OFF CONTROL CARD

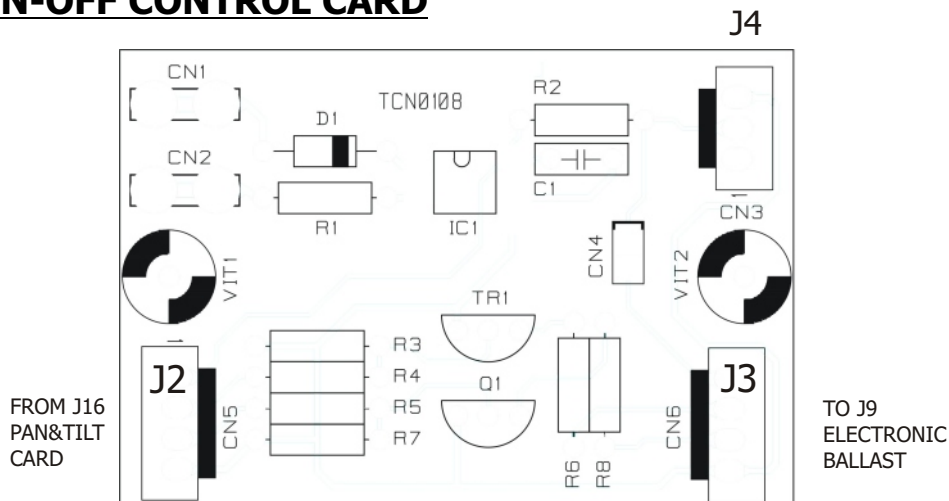

29- ROTATING GOBO WHEEL

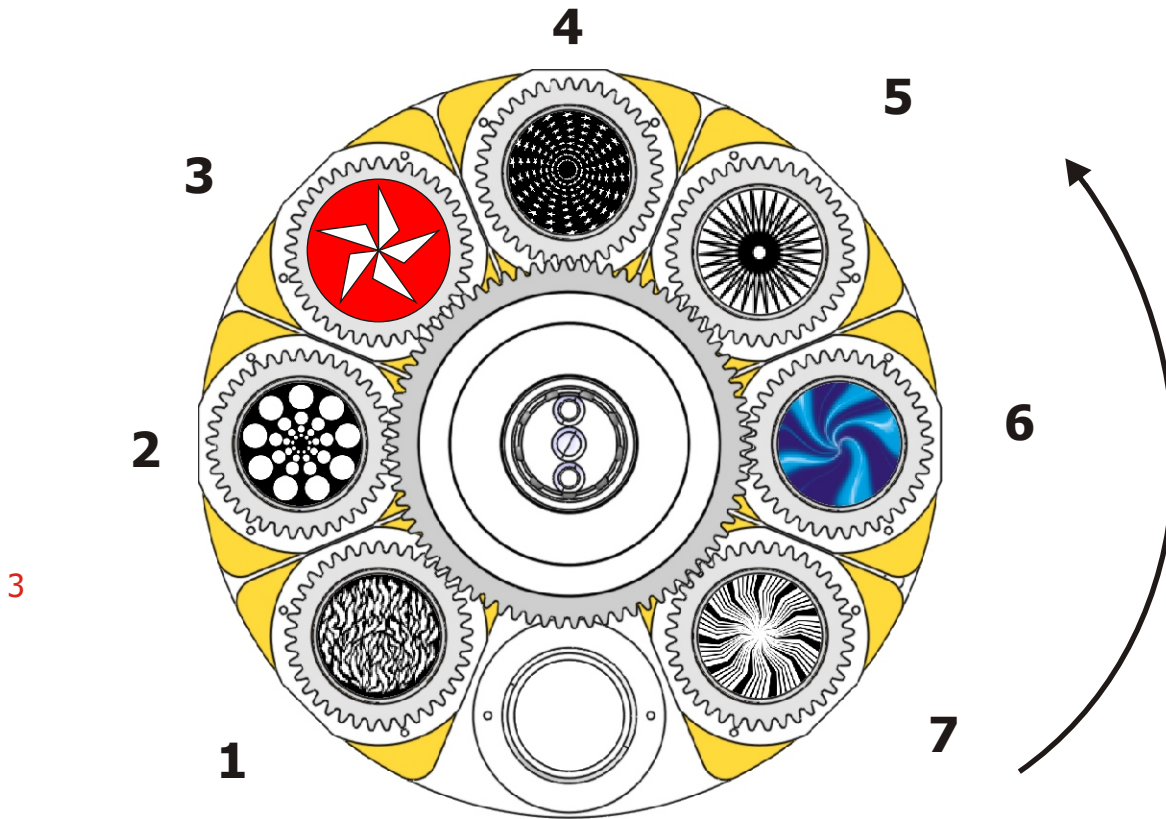

GOBO 1 DICRO



0516G032.01

GOBO 2 DICRO

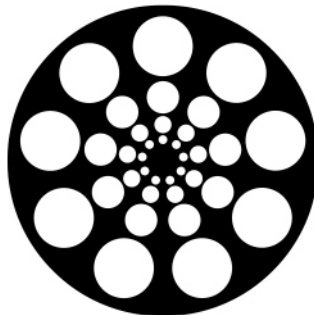

0516G032.08

GOBO 3 DICRO

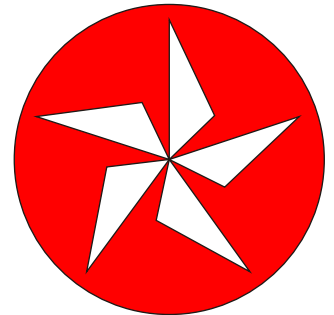

0516G032.12

GOBO 4 DICRO

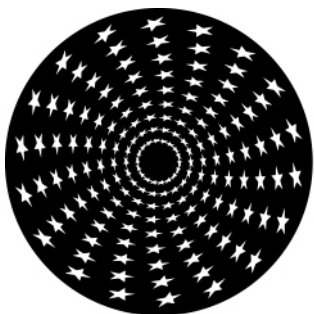

0516G032.10

GOBO 5 DICRO

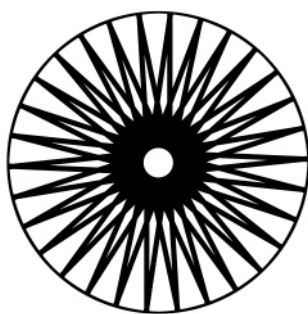

0516G032.11

GOBO 6 DICRO

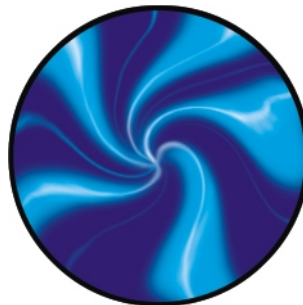

0516G032.03

GOBO 7 DICRO

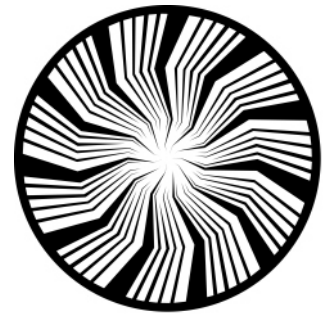

0516G032.05

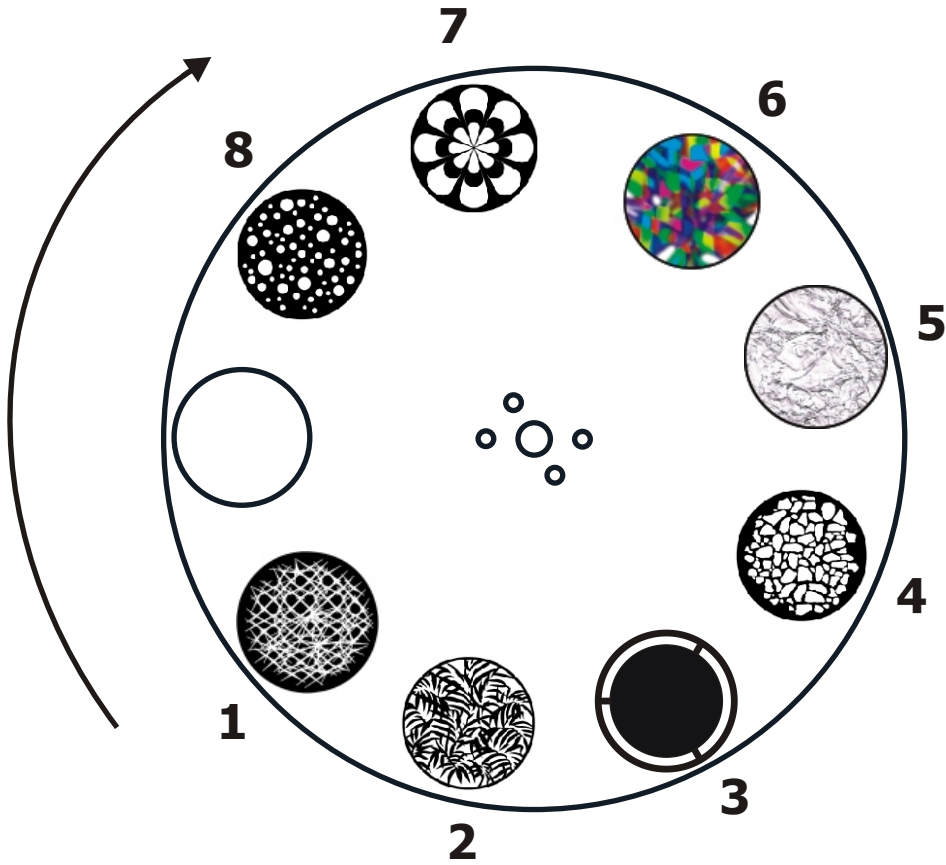
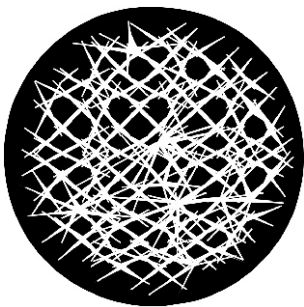
30- FIXED GOBO WHEEL**GOBO 1 DICRO**

0516G032.06

GOBO 2 DICRO

0516G032.04

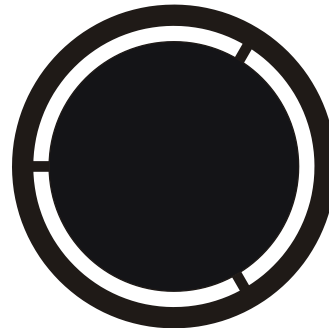
GOBO 3 METAL

0516G032.15.M.58

GOBO 4 DICRO

0516G032.07

GOBO 5 GLASS

0516G032.14

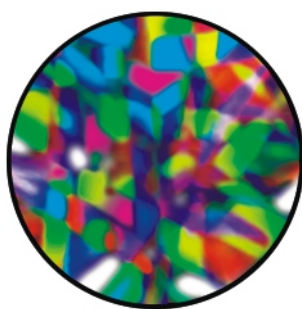
GOBO 6 DICRO

0516G032.09

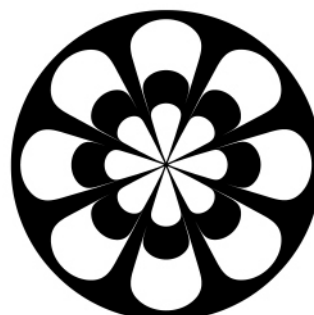
GOBO 7 DICRO

0516G032.13

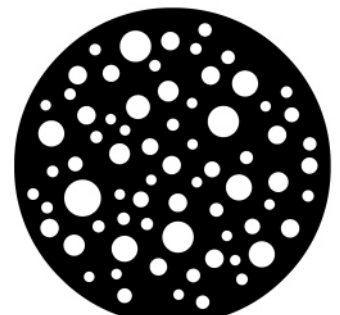
GOBO 8 DICRO

0516G032.02

31- COLOUR WHEEL

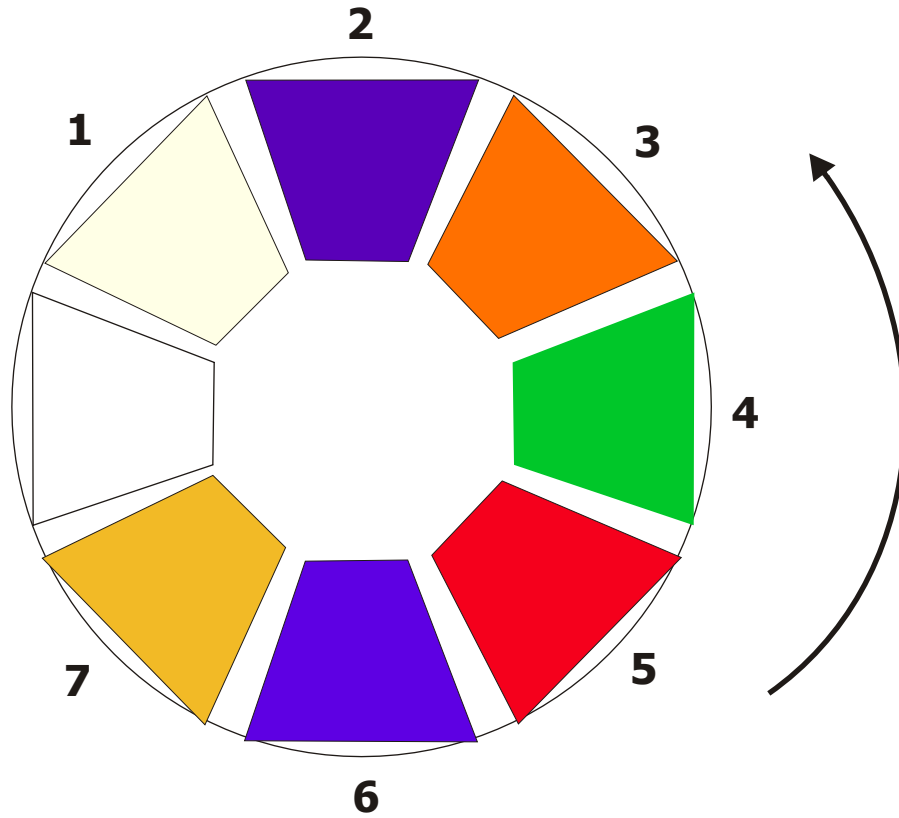

COL 1

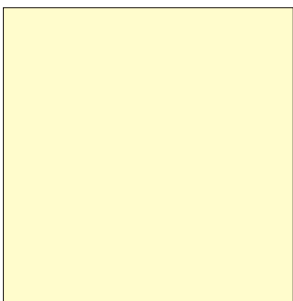

0507K004.D10
CONV.FILTER HOT
TC3256

COL 2

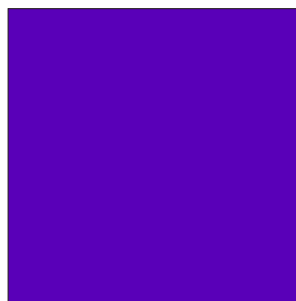

0507C046.D10
WOOD SW460

COL 3

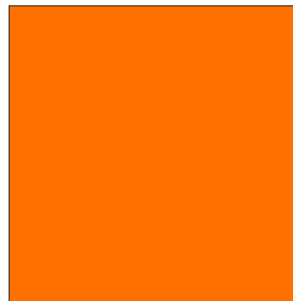

0507C051.D10
ORANGE LW590

COL 4

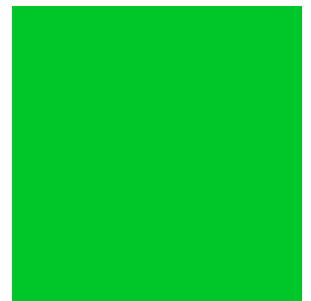

0507C042.D10
GREEN WB5055

COL 5

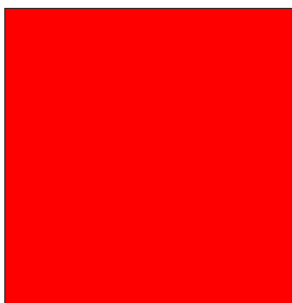

0507C047.D10
RED LW 640

COL 6



0507C041.D10
DARK BLUE SW490

COL 7

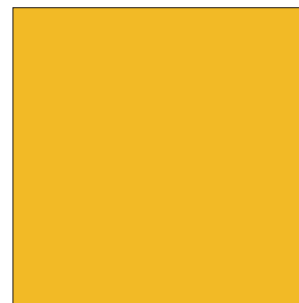

0507C053.D10
AMBER LW550

NOTES

NOTES

NOTES

NOTES

The information contained in this publication has been carefully prepared and checked. However, no responsibility will be taken for any errors. All rights are reserved and this document cannot be copied, photocopied or reproduced, in part or completely, without prior written consent from D.T.S.

D.T.S. reserves the right to make any aesthetic, functional or design modifications to any of its products without prior notice. D.T.S. assumes no responsibility for the use or application of the products or circuits described herein.

MADE IN ITALY



The Lighting Company

ISO 9001:2000

D.T.S. quality system
is certified to the
ISO 9001:2000 standard



D.T.S. products are designed
and manufactured at the D.T.S.
plants in Italy



0517I147